



350 S. St. Charles St. Jasper, In. 47546
Ph. 812.482.2932 Fax 812.634.6632

www.ridetech.com

Part # 11037199
55-57 Chevy Rear AirBar
(Two Piece Frame)

Components:

1	90000160	Driver side lower axle bracket
1	90000558	Passenger side lower axle bracket
1	90000557	Front cross member (35.125")
1	90000554	Upper shock mount
1	90000555	Upper shock mount
20	70013334	R-Joint Spacers
1	90000550	Lower shockwave mount - Driver
1	90000551	Lower shockwave mount - Passenger
4	90002852	Parallel Bars C-C 18.50"
1	90002853	Diagonal bar C-C 30.25"
5	70013364	RH R-Joint Threaded Housing End (installed in bars)
1	70013564	LH R-Joint Threaded Housing End (installed in diagonal bar)
2	90001617	5/8" Shock studs
1	90000266	Brake line tab
5	99752004	3/4"-16 RH Hex jam nut for rod ends
1	99752006	3/4"-16 LH Hex jam nut for rod ends
4	90002067	Aluminum spacer – lower shock bearing

R-Joint Components (installed in bar ends)

70013279	Retaining Ring
70012380	Wavo Wave Spring
70013275	R-Joint Center Ball
70013276	R-Joint Composite Center Ball Cage

AirBAR

Hardware Kit Part # 99010019:

Cross Member Mounting

- 10 3/8"-16 x 1" type F thread forming bolt
- 10 3/8" Lock washer

Lower Shockwave Mounting

- 4 1/2"-20 x 3/4" Gr.5 bolt

4Link Bars

- 10 5/8"-11 Nylok jam nut
- 8 5/8"-11 x 2 3/4" Gr.5 bolt
- 2 5/8"-11 x 3" Gr.5 bolt

Upper Shockwave Mounting

- 2 1/2"-13 x 2 1/4" Gr.5 bolt
- 2 1/2"-13 Nylok jam nut
- 10 3/8"-16 x 1" type F thread forming bolt
- 10 3/8" Lock washer

Brake Line Bracket

- 2 #10 x 3/4" Tek screws

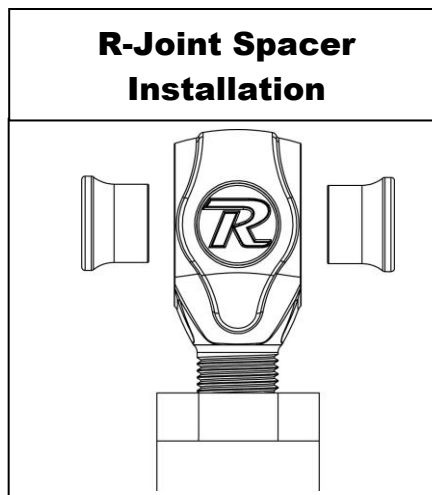

New R-Joints will be quite stiff (75-90 in/lbs breakaway torque) until they "break in" after a few miles of use. After the break in period they will move much more freely. Because the composite bearing race contains self-lubricating ingredients, no additional lubrication is needed or desired. Any additional lubrication will only serve to attract more dirt and debris to the R-Joint and actually shorten its life.

AirBAR

1. Raise the vehicle to a safe and comfortable working height. Use jack stands to support the vehicle with the suspension hanging freely.
2. Support the axle and remove the leaf springs, shocks, bump stops, pinion snubber and tail pipes. Refer to the factory service manual for proper disassemble procedures.



3. The parking brake brackets will be in the way of the 4 link and must be removed. Loosen the parking brake adjustment nut and remove the cable from the frame bracket. The tack weld can be broke loose with a hammer and chisel. Grind the remains of the weld smooth.



4. The rear brake line bracket on the passenger side fame rail must also be removed.



5. Use a couple clamps to secure the crossmember between the frame rails. Slide it forward to the edge of the body mounts. Drill the holes with a 5/16" bit and thread the 3/8" x 1" self-tapping bolts in one at a time.

Do not over tighten the self-tapping bolts; they can be stripped.

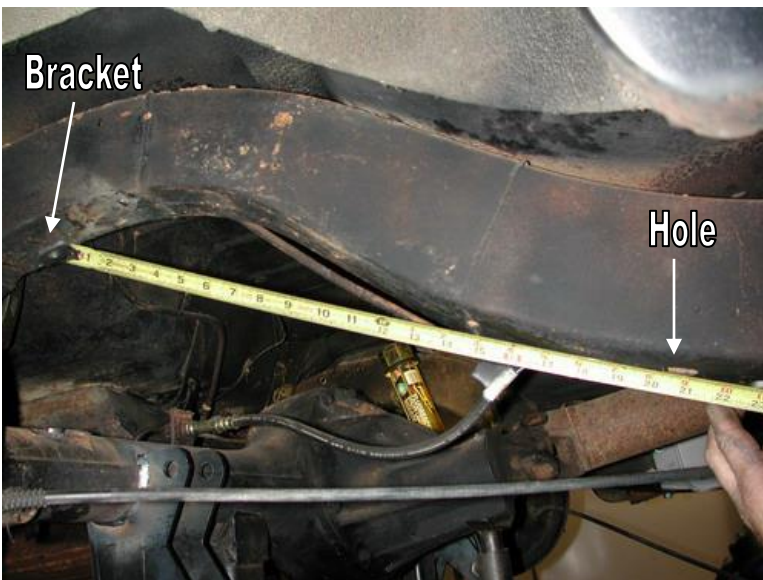

6. The location of the upper Shockwave mount is determined by measuring 14 1/2" from the edge of the bracket to rear edge of the large hole in the bottom of the frame.



7. Use a clamp to hold the bracket against the inside of the frame and drill the holes with a 5/16" bit. Thread a 3/8" x 1" self-tapping bolt into the frame after drilling each hole.

8. Note there is a driver and passenger side bracket and are stamped accordingly. When using the correct bracket the Shockwave will perpendicular with the ground.

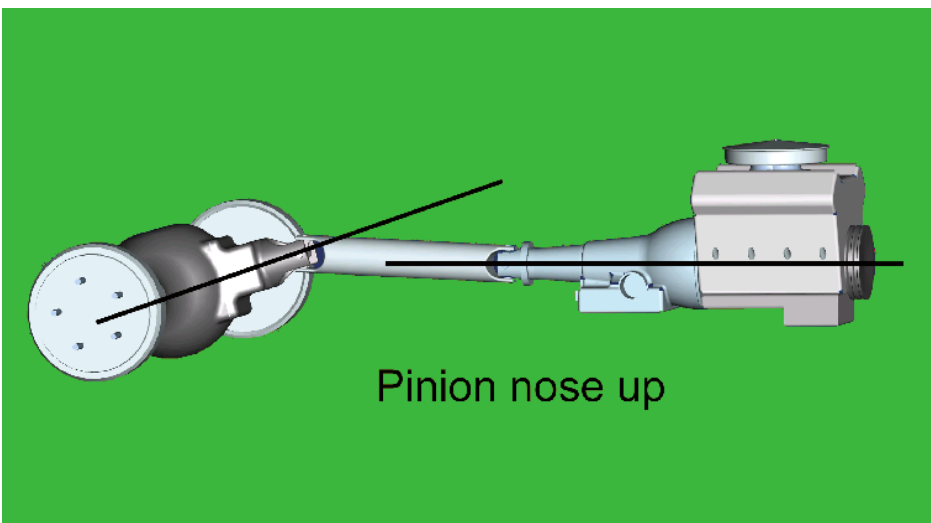
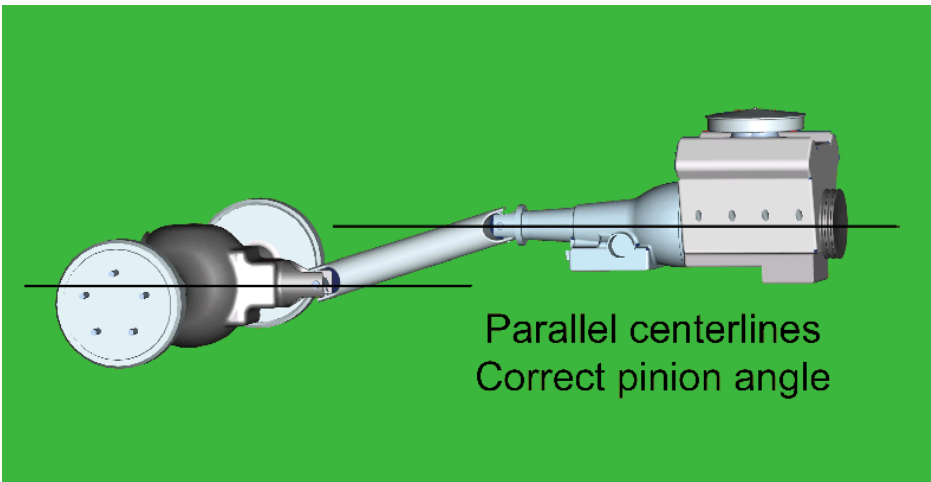
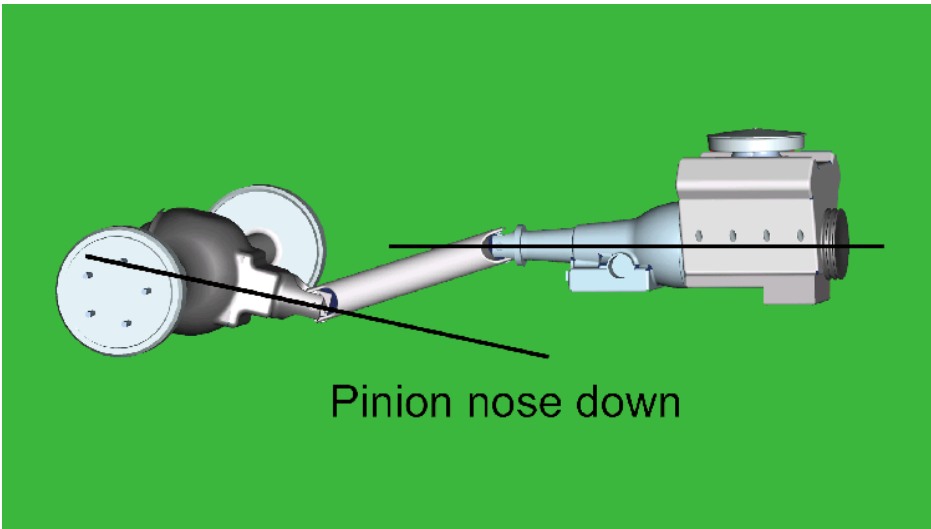

9. How do you set the pinion angle? On a single-piece shaft you want to set it up where a line drawn through the center of the engine crankshaft or output shaft of the transmission and a line drawn through the center of the pinion are parallel to each other but not the same line.

Your transmission angle should be around 3 degrees down in the rear. If it is more or less than 3 degrees, you might want to consider changing it. Too little angle on the transmission reduces the amount of oil getting to the rear bushing. Too much transmission angle will increase the working angles of the u-joints which will increase the wear. With the transmission at 3 degrees down in the rear, you will want to set the pinion 3 degrees up in the front.

A simple way to do this is to place a digital angle finder or dial level on the front face of the lower engine pulley or harmonic balancer. This will give you a reading that is 90 degrees to the crank or output shaft unless you have real problems with your balancer. At the other end, you can place the same level or angle finder against the front face of the pinion yoke that is also at 90 degrees to the centerline. If you rotate the yoke up or down so both angles match, you have perfect alignment.

Road testing will tell you if you have it right. If you accelerate and you get or increase a vibration, then the pinion yoke is too HIGH. Rotate it downward in small increments of a degree or two until the problem goes away. If you get or increase a vibration when decelerating, then the pinion yoke is too LOW. Rotate it upward to correct it.



10. Pinion angle must be set at ride height. At ride height there should be 4 1/2" between the axle and frame.

11. One trick to help maintain these setting while welding in the axle bracket is to tack weld a 4 1/2" long spacer between the axle and frame.

12. After setting the pinion angle, make sure the axle is centered. This can done by measuring from the axle flange in to the frame rail.



13. Insert the R-Joint spacers into the R-joint with the small OD inserted into the R-Joint center pivot. Install the 4 link bars into the crossmember and axle bracket. Use the 5/8" x 2 3/4" bolts and nyloks supplied. Check the length of the bars; they should be 18 1/2" C-C.

14. There is a driver and passenger side bracket. The passenger side bracket has the diagonal link bracket welded to it. These rod ends will use a 3" bolt. You can use a large hose clamp to hold these in place temporarily.

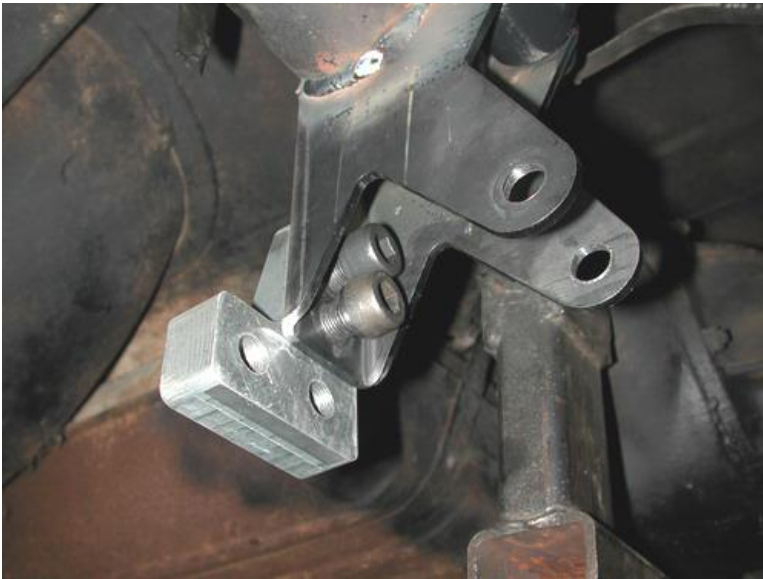

15. Swing the axle bracket up to the axle. These brackets must be centered and aligned with the crossmember mounts before welding. The brackets should be 31 5/8" apart on the outside measurement. Then just center it between the axle flanges.

16. Tack weld the bracket to the axle. Double-check axle center, bracket alignment, and pinion angle. Remove the bars to avoid frying the bushings. Then finish welding the bracket 1" at a time in different spots to avoid warping the axle.



17. Bolt the lower Shockwave mount to the axle bracket using the 1/2"-20" x 3/4" Hex Head Bolt. Apply anti-seize to the threads. It is easier to remove the bars to install these bolts.

18. There is a driver and passenger side bracket; the correct bracket will offset the Shockwave toward the wheel.

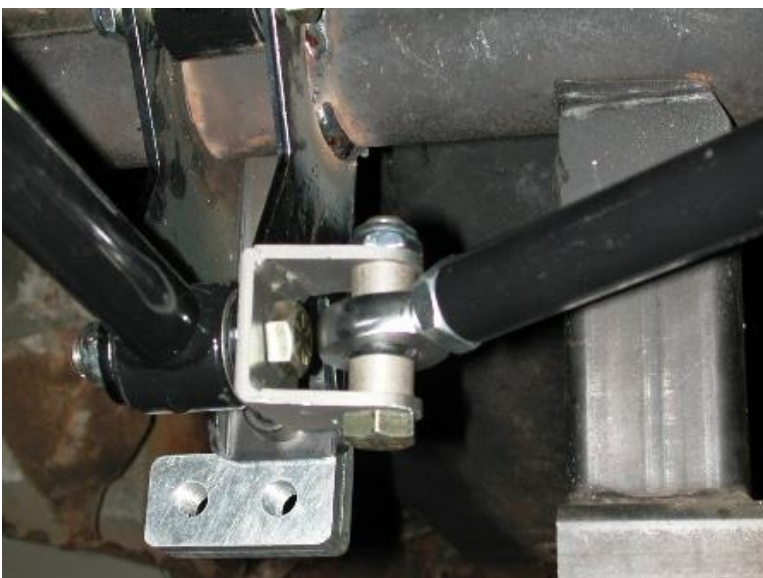

19. Insert the R-Joint spacers into the R-joint with the small OD inserted into the R-Joint center pivot. Bolt the diagonal link into place using a 5/8" x 2 3/4" bolt and nylok. It should measure 30 1/4" C-C.

20. Install the parking brake cable into the new tab on the cross member.

21. With the axle at ride height snug all the 4 link bolts. These bushings are rubber and do not require lubrication.

22. Apply thread sealant onto the air fitting and screw it into the top of the shockwave. Air fitting location can be moved by rotating the hellow assembly



25. Remove the spacer from between the axle and frame.

26. A new brake line tab is supplied and will mount just below the original. Make sure it clears the bar through full suspension travel.

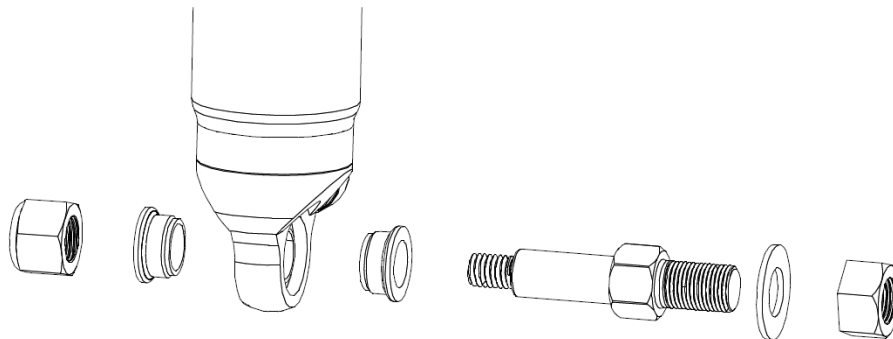

27. Driving height will be with approximately 13" from center eye to center eye.

